

# LTC3858EUH

## POLYPHASE HIGH VOUT SYNC. BUCK CONVERTER

### DESCRIPTION

Demonstration circuit 1510A is a high output voltage, high efficiency synchronous poly-phase buck converter featuring the LTC3858EUH. The demo circuit is available in two versions. The input voltage of both versions is 16V to 26V. DC1510A-A is configured using 2 piece of LTC3858EUH with 4 phase interleaving operation which provides 12V/50A output, while the DC1510A-B is configured with 1 piece of LTC3858EUH with 2 phase interleaving operation which provides 12V/25A output.

The board has a Mode selection jumper that allows the converter to run in Forced CCM Mode, Pulse Skip Mode or Burst Mode operation. Synchronization to an external clock (frequency range 150kHz to 500kHz) is also possible on this board.

The demo circuit senses inductor current with sensing resistor but also has an optional DCR sense circuit that allows using the inductor's DCR as the current sensing element to save cost, footprint and improve efficiency.

The LTC3858EUH datasheet gives a complete description of these parts, operation and application information and must be read in conjunction with this quick start guide for Demonstration circuit 1510A.

**Design files for this circuit board are available. Call the LTC factory.**

LT, LTC, LTM, LT, Burst Mode, OPTI-LOOP, Over-The-Top and PolyPhase are registered trademarks of Linear Technology Corporation. Adaptive Power, C-Load, DirectSense, Easy Drive, FilterCAD, Hot Swap, LinearView, µModule, Micropower SwitcherCAD, Multimode Dimming, No Latency ΔΣ, No Latency Delta-Sigma, No RSENSE, Operational Filter, PanelProtect, PowerPath, PowerSOT, SmartStart, SoftSpan, Stage Shedding, SwitcherCAD, ThinSOT, UltraFast and VLDO are trademarks of Linear Technology Corporation. Other product names may be trademarks of the companies that manufacture the products.

**Table 1. Performance Summary (T<sub>A</sub>=25°C)**

PARAMETER	CONDITIONS	MIN	TYP	MAX	UNITS
Input Supply Range		16		26	V
Output Voltage Range	V <sub>IN</sub> = 24V, V <sub>OUT</sub> = 12 V	11.82	12	12.18	V
Nominal Switching Frequency			250		kHz
Full Load Efficiency (See Figure 3 for efficiency curves)	V <sub>IN</sub> = 24V, V <sub>OUT</sub> = 12V, I <sub>LOAD</sub> = 50A (-A) / 25A (-B)		97.3		%

### QUICK START PROCEDURE

Demonstration circuit 1510A is easy to set up to evaluate the performance of the LTC3858EUH. Refer to Figure 1 for proper measurement equipment setup and follow the procedure below:

**NOTE.** When measuring the input or output voltage ripple, care must be taken to avoid a long ground lead on the oscilloscope probe. Measure the input or output voltage ripple by touching the probe tip directly across the Vin or Vout and GND terminals. See Figure 2 for proper scope probe technique.

1. Place jumpers in the following positions:

**JP1 MODE** CCM

**JP2 RUN** ON

**JP3 RUN** ON

2. With power off, connect the input power supply to VIN and GND. Connect the load to the output. The load current should be smaller than 50A for DC1510A-A and smaller than 25A for DC1510A-B.

# LTC3858EUH

3. Turn on the power at the input.

**NOTE.** Make sure that the input voltage does not exceed 36V.

4. Check for the proper output voltage.  $V_{OUT} = 11.82V$  to 12.18V

5. Once the proper output voltages are established, adjust the loads within the operating range and observe

the output voltage regulation, ripple voltage, efficiency and other parameters.

6. Different operating modes can be evaluated by changing the position of JP1 **MODE** jumper and are discussed in the next section.

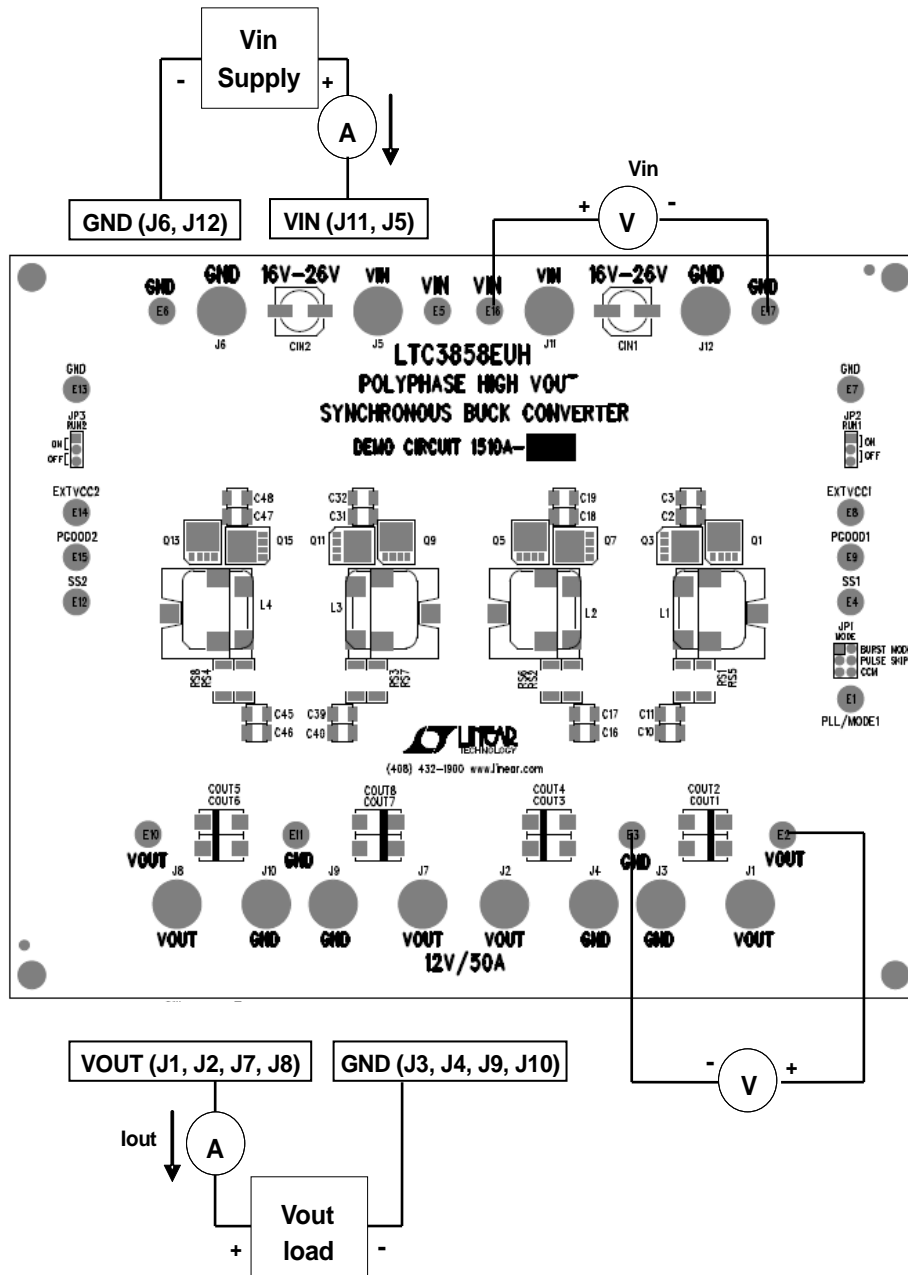

Figure 1. Proper Measurement Equipment Setup

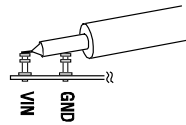

Figure 2. Measuring Input or Output Ripple

## FREQUENCY SYNCHRONIZATION AND MODE SELECTION

Demonstration circuit 1510A's Mode selector allows the converter to run in Forced CCM Mode, Pulse Skip Mode or Burst Mode operation by changing position of **JP1 MODE** jumper. For synchronizing to an external clock source, **JP1 MODE** jumper needs to be removed.

Apply the external clock (frequency range 150kHz to 500kHz) from the **PLL/MODE1** turret to **GND**. Refer to Table 2 and to the data sheet for more details.

**Note:** Please don't use Burst Mode in 4 phase interleaving operation

Table 2. Mode Selection and Synchronizing Operation Options

CONFIGURATION	PLL/MODE1 JUMPER
Forced CCM Mode Operation	"CCM"
Pulse Skip Mode Operation	"PULSE SKIP"
Burst Mode Operation	"BURST MODE"
Synchronize to Ext. clock (Ext. clock apply to MODE/PLLIN turret)	Remove Jumper

## OPTIONAL INDUCTOR DCR CURRENT SENSING

Demonstration circuit 1510A provides an optional circuit for Inductor DCR Current Sensing. Inductor DCR Current Sensing uses the DCR of the inductor to sense the inductor current instead of discrete sense resistors. The advantages of DCR sensing are lower cost, re-

duced board space and higher efficiency, but the disadvantage is a less accurate current limit. If DCR sensing is used, be sure to select an inductor current with a sufficiently high saturation current or use an iron powder type. Refer to the datasheet for more details.

DC1510A (LTC3858EUH) Demo Circuit Efficiency  
24Vin to 12Vo @250kHz

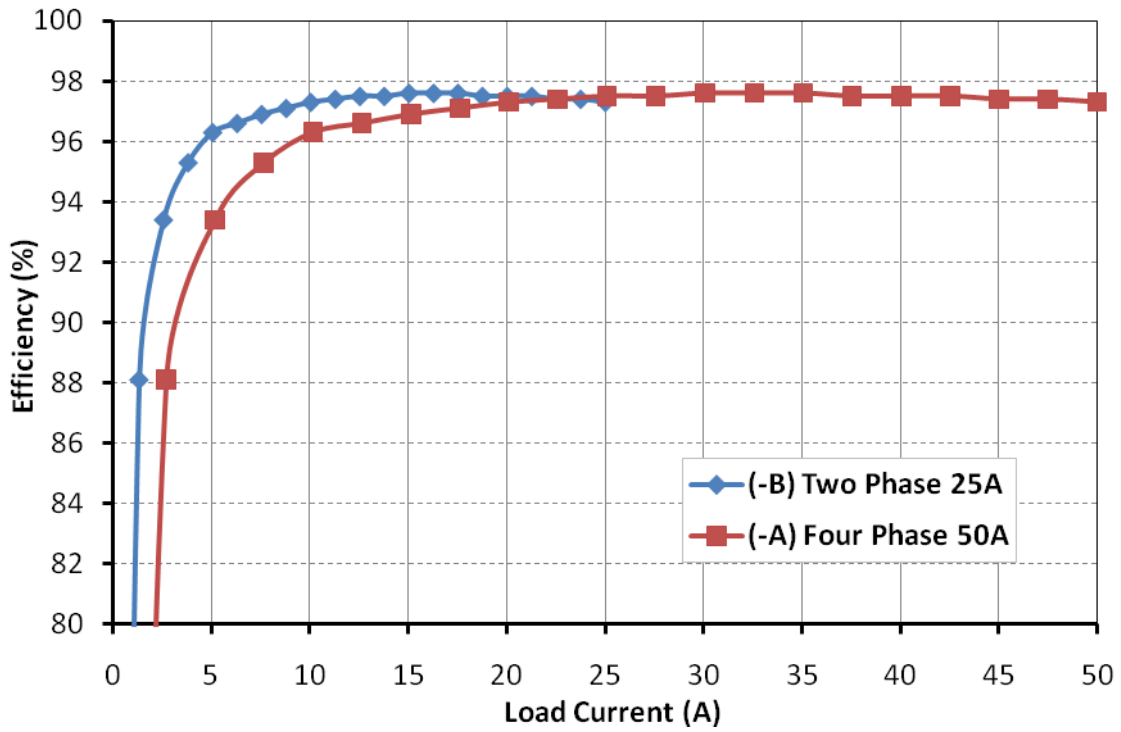
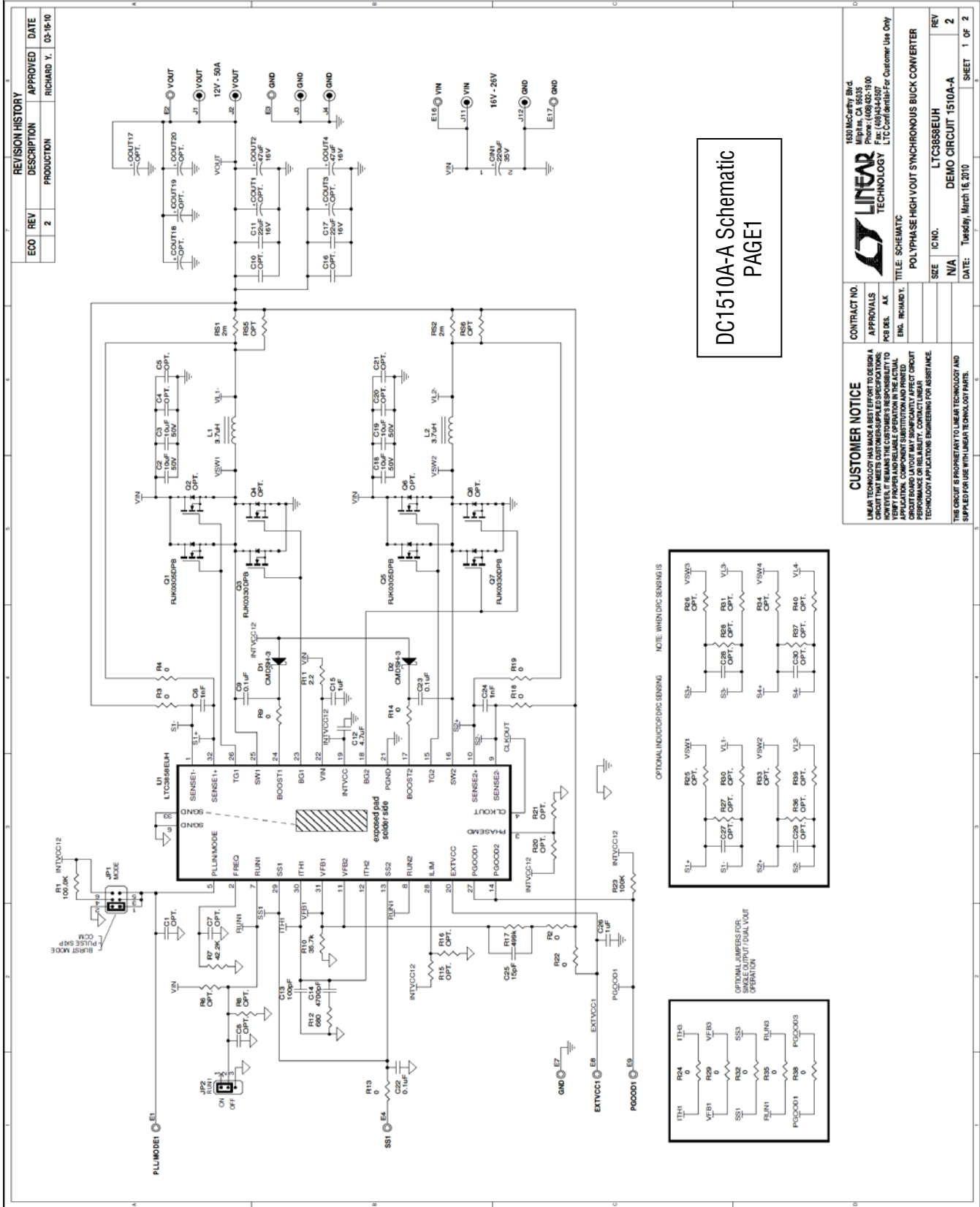

Figure 3. Efficiency Curve for Demonstration Circuit 1510A



REVISION HISTORY		
ECO	REV	DESCRIPTION
	2	PRODUCTION

APPROVED	DATE
RICHARD Y.	03-16-10

<b>CUSTOMER NOTICE</b>	
LINEAR TECHNOLOGY HAS MADE A BEST EFFORT TO DESIGN A BOARD THAT WILL OPERATE AS DESCRIBED IN THE SCHEMATIC. HOWEVER, IT REMAINS THE CUSTOMER'S RESPONSIBILITY TO VERIFY PROPER AND RELIABLE OPERATION IN THE ACTUAL APPLICATION. LINEAR TECHNOLOGY WILL NOT BE RESPONSIBLE FOR PERFORMANCE OR RELIABILITY. CONTACT LINEAR TECHNOLOGY APPLICATIONS ENGINEERING FOR ASSISTANCE.	
CONTRACT NO.	1510A-001
APPROVALS	AK
PCB REL.	AK
ENG.	RICHARD Y.
TITLE	SCHEMATIC
SIZE	IC.ND.
REV	LTC3858EUH
DATE	DEMOCIRCUIT-1510A-A
SHEET	1 OF 2

1510 McCarty Blvd.  
Milpitas, CA 95035  
Phone: (415) 961-1900  
Fax: (415) 961-1945  
E-Mail: [info@linear.com](mailto:info@linear.com)  
LTC Cont. Identifies For Customer Use Only

**LINEAR TECHNOLOGY**

POLYPHASE HIGH VOLT SYNCHRONOUS BUCK CONVERTER

THE CIRCUIT IS PROPRIETARY TO LINEAR TECHNOLOGY AND SUPPLIED FOR USE WITH LINEAR TECHNOLOGY PARTS.

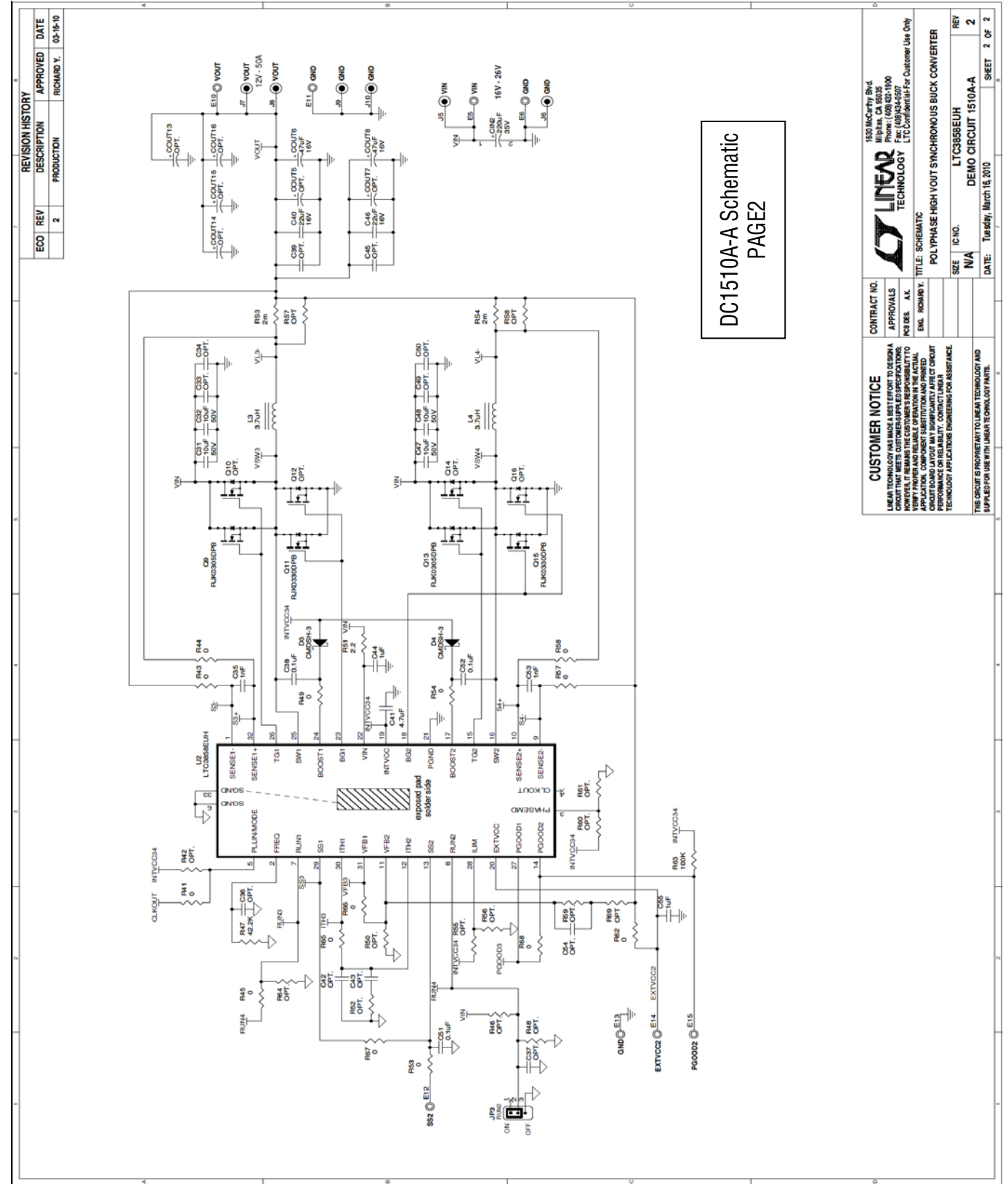

DC1510A-A Schematic  
PAGE2

**CUSTOMER NOTICE**  
 LINEAR TECHNOLOGY HAS MADE A BEST EFFORT TO DESIGN A CIRCUIT THAT MEETS CUSTOMER-SPECIFIED REQUIREMENTS. HOWEVER, IT REMAINS THE CUSTOMER'S RESPONSIBILITY TO VERIFY THE OPERATION OF THE CIRCUIT IN THEIR FINAL APPLICATION. COMPONENT SUBSTITUTION AND PRINTED CIRCUIT BOARD LAYOUT MAY SIGNIFICANTLY AFFECT CIRCUIT PERFORMANCE. LINEAR TECHNOLOGY PROVIDES THIS TECHNOLOGY APPLICATIONS ENGINEERING FOR ASSISTANCE.

**CONTRACT NO.**  
 APPROVALS  
 PCB DEL. A.K.  
 ENG. RICHARD Y.

**1530 McCarty Blvd**  
**Milpitas, CA 95035**  
**Phone: (408) 932-1900**  
**Fax: (408) 934-8007**  
**LTC Confidential - For Customer Use Only**

**LINEAR TECHNOLOGY**  
**LTC3858EUH**  
**POLYPHASE HIGH VOLT SYNCHRONOUS BUCK CONVERTER**

**SIZE** IC NO. **LTC3858EUH** **REV**  
**N/A** **DEMO CIRCUIT 1510A-A** **2**

**DATE:** Tuesday, March 16, 2010 **SHEET** 2 OF 2

**THIS CIRCUIT IS PROPRIETARY TO LINEAR TECHNOLOGY AND SUPPLIED FOR USE WITH LINEAR TECHNOLOGY PARTS.**

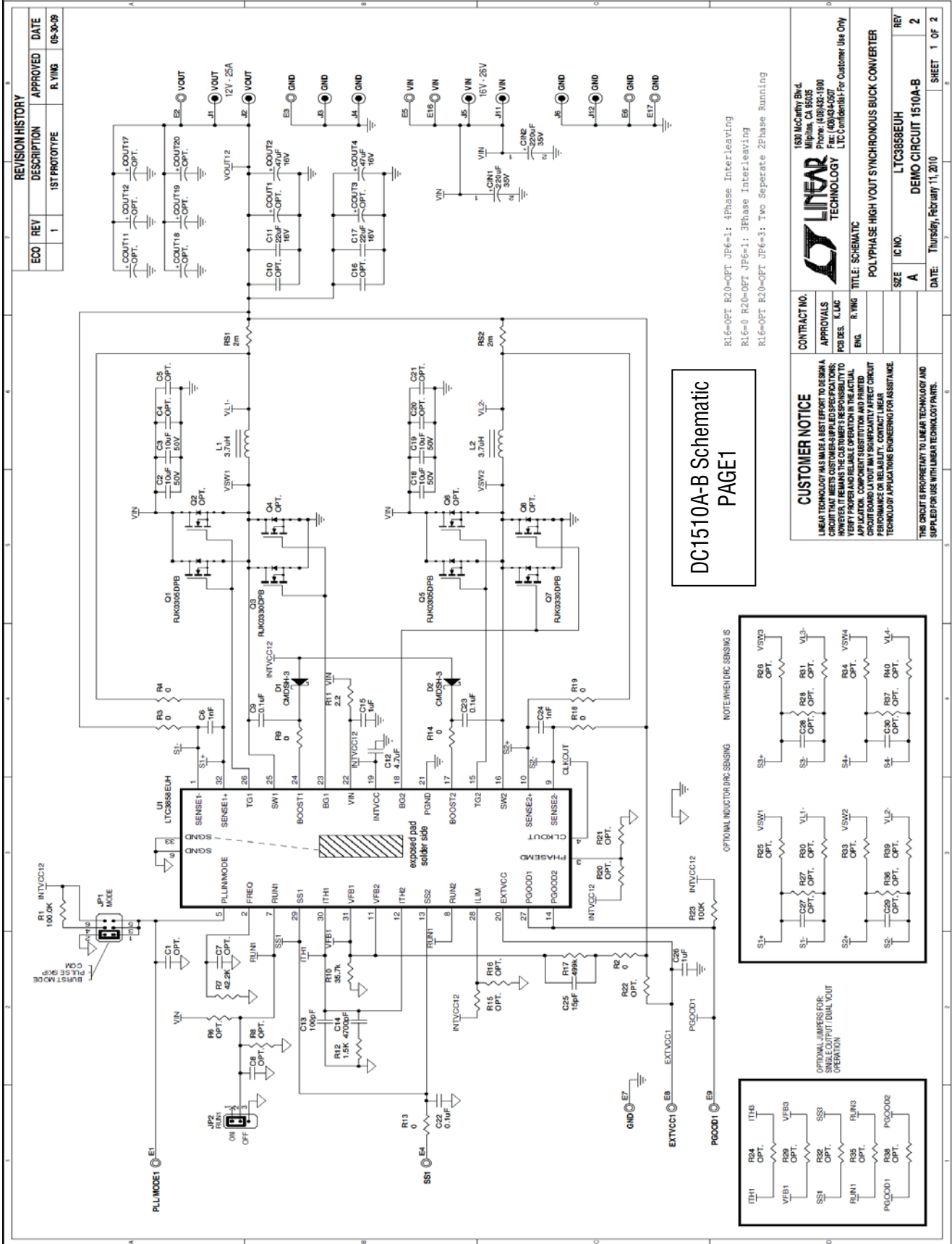

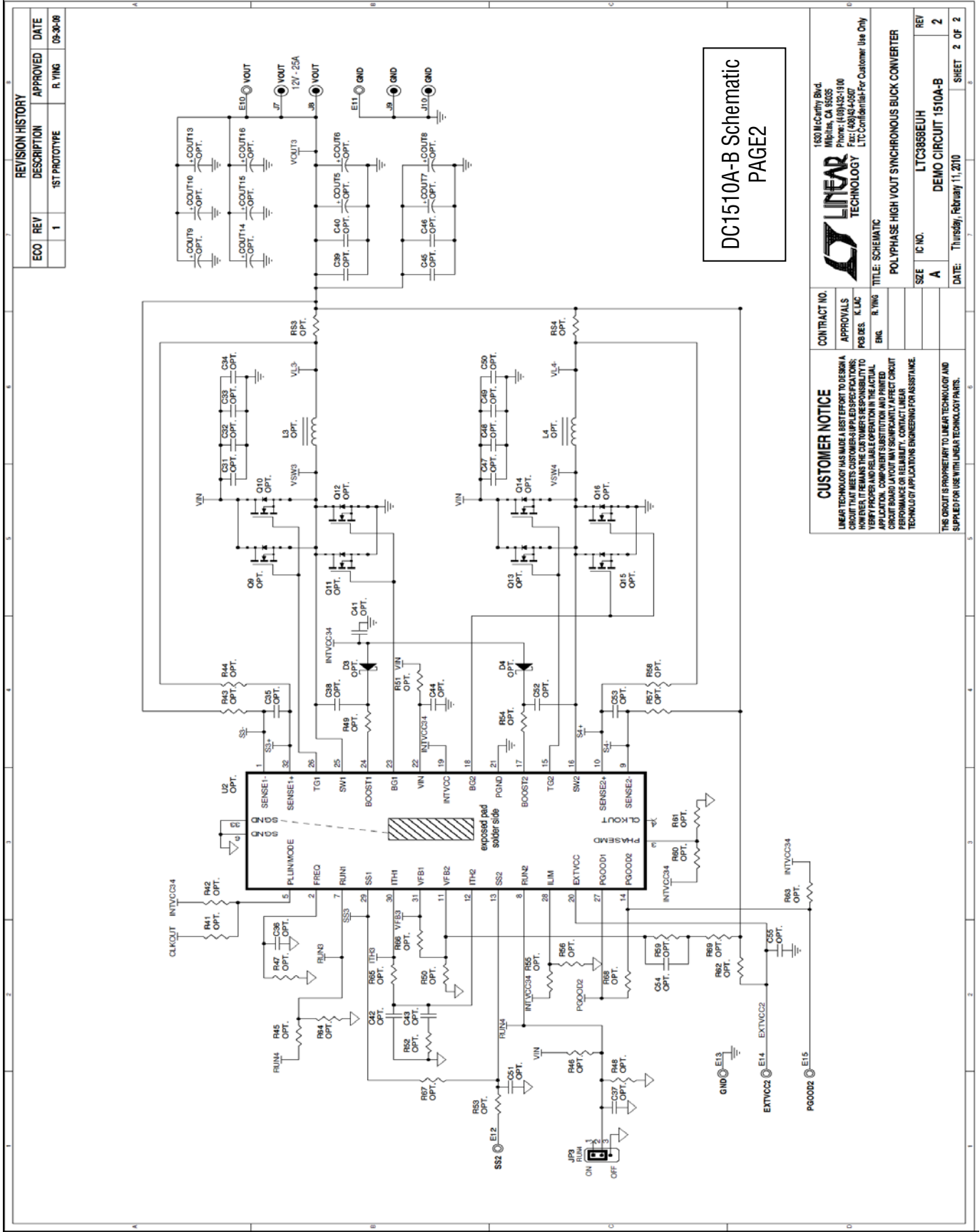

**REVISION HISTORY**

ECO	REV	DESCRIPTION	APPROVED	DATE
	1	1ST PROTOTYPE	R. YANG	08-20-08

DC1510A-B Schematic  
PAGE 2

**CUSTOMER NOTICE**  
 LINEAR TECHNOLOGY HAS MADE A BEST EFFORT TO DESIGN A CIRCUIT THAT MEETS CUSTOMER-SUPPLIED SPECIFICATIONS; HOWEVER, IT REMAINS THE CUSTOMER'S RESPONSIBILITY TO VERIFY PROPER AND RELIABLE OPERATION IN THE ACTUAL APPLICATION. COMPONENT SUBSTITUTION AND PRINTED CIRCUIT BOARD MANUFACTURING VARIATIONS MAY AFFECT PERFORMANCE OR RELIABILITY. CONTACT LINEAR TECHNOLOGY APPLICATIONS ENGINEERING FOR ASSISTANCE.

**CONTRACT NO.**  
 APPROVALS  
 PCB DES. LUC  
 ENG. R. YANG

1800 McCarthy Blvd.  
 Milpitas, CA 95035  
 Phone: (408)434-1910  
 Fax: (408)434-0807  
 LTC Confidential-For Customer Use Only

**LINEAR TECHNOLOGY**

TITLE: SCHEMATIC  
 POLYPHASE HIGH VOLT SYNCHRONOUS BUCK CONVERTER

SIZE IC NO. LDC3858EUH REV 2  
 A DEMO CIRCUIT 1510A-B SHEET 2 OF 2

DATE: Thursday, February 11, 2010